

Experimental Manual MCA with Anuspect



 **NUCLEONIX SYSTEMS PVT. LTD**

CHAPTER – III
PROCEDURE FOR OPERATION OF MULTI CHANNEL ANALYSER

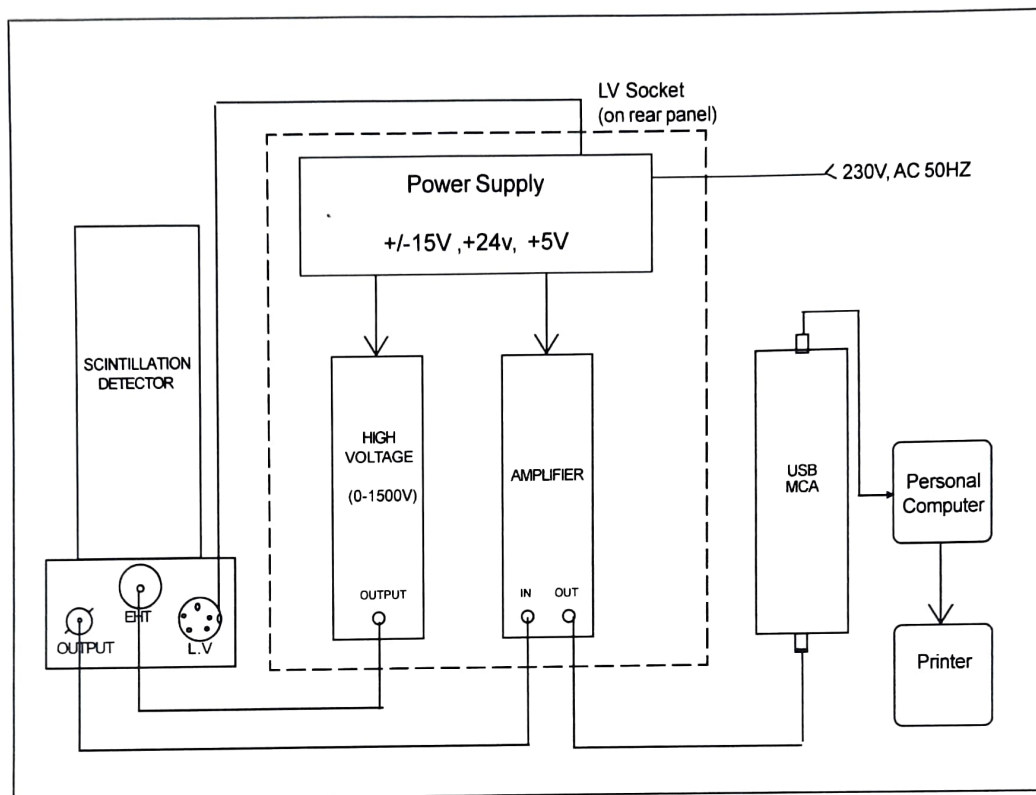

Fig.1. Block diagram USB MCA

- Make the interconnections as shown in the table given below & also in above in Fig.1. Switch on PC & Gamma Ray Spectrometer.
- Invoke the 'ANUSPECT' software on PC by double clicking on the 'ANUSPECT' icon on the desktop.
- Then the main screen that appears at the start of the program is shown below in Fig.2.

Table showing system inter connection details

| Sl.No. | Name of the connecting cable | Connection from | Connection to |
|--------|-------------------------------|------------------------|--|
| 1 | BNC to BNC co-axil cable | Scintillation detector | Spectroscopy amplifier INPUT |
| 2 | UHF to MHV cable | -do- | High voltage unit |
| 3 | LV cable | -do- | Instrumentation bin with power supply MB404 rear panel |
| 4 | Spectroscopy amplifier output | MCA (USB) module input | |
| 5 | USB cable | MCA module | Personal computer |
| 6 | Printer cable | PC | printer |

CHAPTER - IV
EXPERIMENTS WITH ANUSPECT SOFTWARE

EXPERIMENT – 1

**STUDY OF Cs-137 SPECTRUM AND CALCULATION OF FWHM & RESOLUTION
FOR A GIVEN SCINTILLATION DETECTOR**

PURPOSE:

Resolution is an important parameter which determines the quality of any scintillation detector. The purpose of this experiment is to calculate FWHM (Full Width at Half Maximum of the Photo peak) and resolution for a given Scintillation detector.

PROCEDURE:

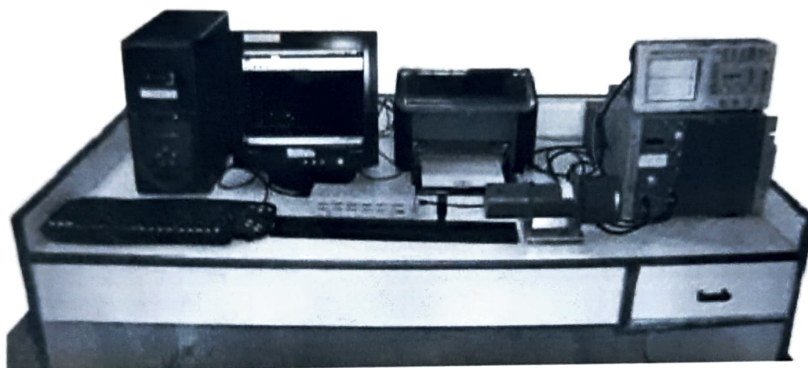

Fig 1 Experimental setup

1. Make system interconnections & default settings.
2. Place a Cs-137 radioactive standard source at a distance of 4 to 5 cm from the face of the scintillation detector.
3. Set HV on the instrument to **750 Volts**, the recommended operating voltage for the scintillation detector used for these experiments.
4. Adjust the amplifier gain such that the photo-peak of 662 keV gammas of Cs-137 will appear at approximately channel 300.
5. Accumulate the Cs-137 spectrum for a time period long enough to get a clear photo-peak. Normally 100 or 200 seconds is enough to get a good photo-peak.

6. The „Print Screen“ of the spectrum is obtained using the procedure outlined in the previous section and the same will appear as shown in Fig.2

7. Take a printout of the ROI report as per the procedure outlined in the previous section. The ROI report will appear as shown in ROI report – 1.

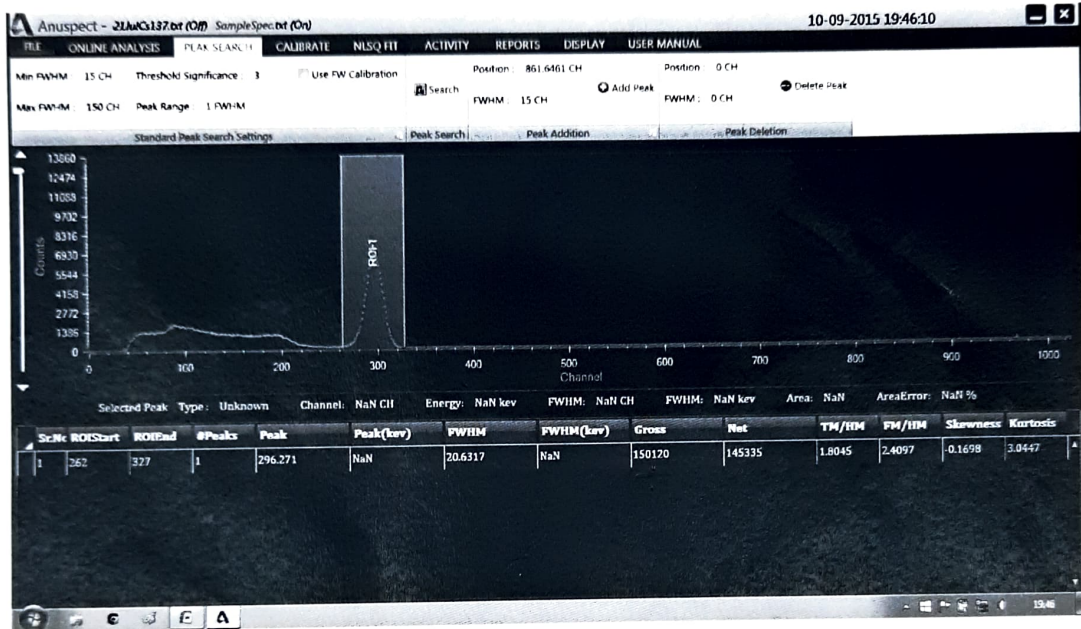

Fig.2 Cs-137 Spectrum

Offline ROI

Report:-

| Start | End | #Pks | Peak | En | FW(C) | FW (E) | TM/HM | FM/HM | Gross | Net |
|-------|-----|------|----------|-----|---------|--------|--------|--------|--------|--------|
| 260 | 326 | 1 | 296.2694 | NaN | 20.6324 | NaN | 1.8046 | 2.4118 | 150392 | 145367 |

DATA ANALYSIS & COMPUTATIONS:

- **FWHM:** Full width at half maximum is the channel width of the Cs-137 spectrum at half the peak height.

From the ROI report -1,

$$\text{FWHM} = 20.6324 \text{ channels}$$

$$\text{Peak channel} = 296.2694$$

- **Resolution:** Resolution of a NaI scintillation detector is defined as the ratio of FWHM divided by peak channel.
- From the ROI report-1, the photo-peak is appearing at channel 306.5.

$$\text{Hence, Resolution} = (\text{FWHM} / \text{Peak channel}) = 20.6324 / 296.2694 = 0.069 = 6.9\%$$

- Both resolution & FWHM are important for NaI scintillation detectors and are universally specified with a Cs-137 standard source by the manufacturer of the detector when they supply. Typically resolution for these detectors range from 7.5 % to 9.5%. Resolution is also specified sometimes in keV. This is calculated and illustrated in the later experiments.

EXPERIMENT – 2

STUDY OF Co-60 SPECTRUM AND CALCULATION OF RESOLUTION OF DETECTOR IN TERMS OF ENERGY

PURPOSE:

Sometimes the resolution of a scintillation detector is expressed in terms of energy. The purpose of this experiment is to calculate the resolution of a Scintillation detector in terms of energy (keV / Channel) with the help of Co-60 Spectrum.

PROCEDURE:

The experimental setup used is same as that shown in Fig. 1.

If Experiment-1 was performed and this is a continuation of that, then same settings are to be retained and only Cs-137 source is to be replaced by Co-60 source. If one is doing afresh this experiment, then proceed as below:

1. Make system interconnections & default settings so as to get the Cs-137 peak at approximate channel 300.
2. Place a Co-60 radioactive source preferably 2 to 3 cm away from the face of the detector.
3. Set the live time to 1000 Sec.
4. Record the spectrum.
5. Note down the channel numbers where the maximum heights of the 1.17 & 1.33 MeV photo-peaks are appearing.
6. Now assuming zero energy intercept at the origin, compute peak channel difference and energy difference from the table for calculation of keV per channel.
7. Take the „Print Screen“ of the Co-60 spectrum, which appears as in Fig. 3.
8. Printout the ROI report of 1170 keV (1.17MeV) & 1330 keV (1.33MeV) peaks, which appear as in ROI reports

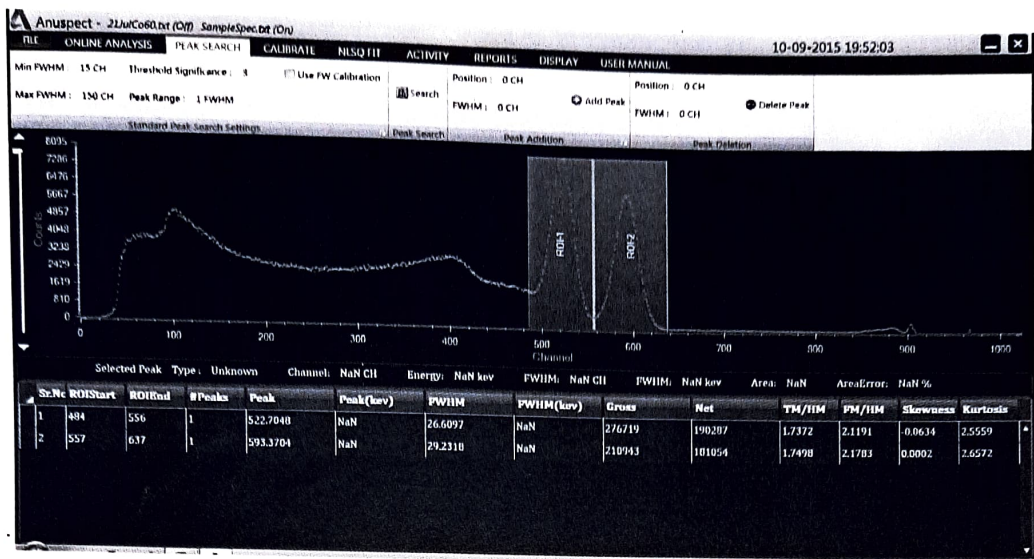

Fig. 3. Co-60 spectrum

Co-60 spectrum

Calculation of per channel keV : Co-60 peak energies are known to be 1.17 MeV & 1.33 MeV. From the ROI report

We know that the peaks are appearing at the channels mentioned below.

1.17 MeV peak at 522.75 channel

1.33 MeV peak is at 593.37 channel

Energy difference = $1.33 - 1.17 = 0.16\text{MeV} = 160\text{keV}$

Channel difference = $593.37 - 522.75 = 70.62$ channel

70.66 channels correspond to 160 KeV

1 channel corresponds to $160 / 70.62 = 2.26$ KeV

From the ROI report-4, it can be observed that FWHM is 20.63 channels.

In terms of energy, $\text{FWHM} = 20.63 \times 2.26 = 46.71\text{KeV}$

Hence, Resolution = $\text{FWHM} / \text{Peak channel energy} = 46.71/662 = 0.0710 = 7.1\%$

EXPERIMENT-3

ENERGY CALIBRATION OF GAMMA RAY SPECTROMETER(LINEARITY STUDY)

(DIRECT METHOD-FROM SOFTWARE)

Purpose:

To study the behaviour of the gamma Ray Spectrometer with different energies of Gamma Sources.

Procedure:

1. Make the system interconnections & default settings so as to get the Cs-137 peak approximately at chanel 300.
2. Place different Energy sources on the detector 2cm away. (minimum 3 energies are required for Energy Calibration)
3. Acquire the spectrum to get a fine spectrum after giving the default settings and file name
4. Click file menu, spectrum and load the spectrum to be calibrated energy shape

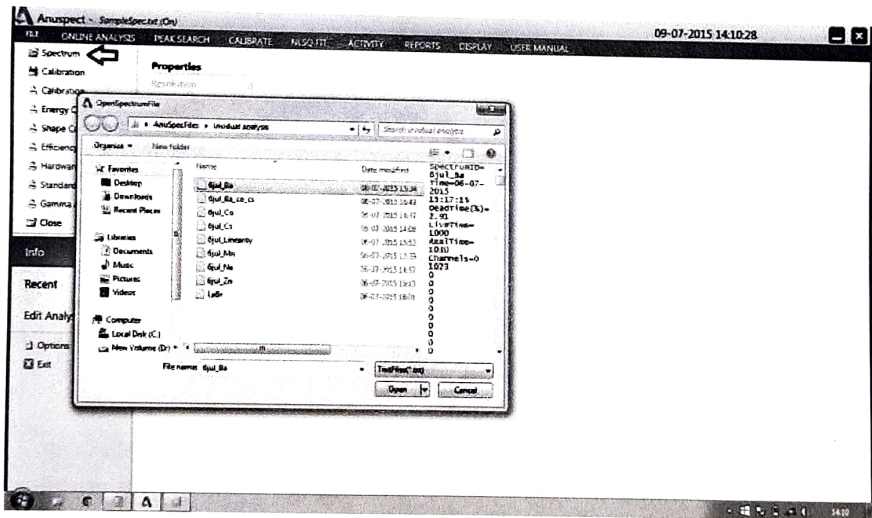

5. Click NO for loading Previous Calibration.
6. Click Peak search menu, search now all the peaks will be detected in the acquired spectrum

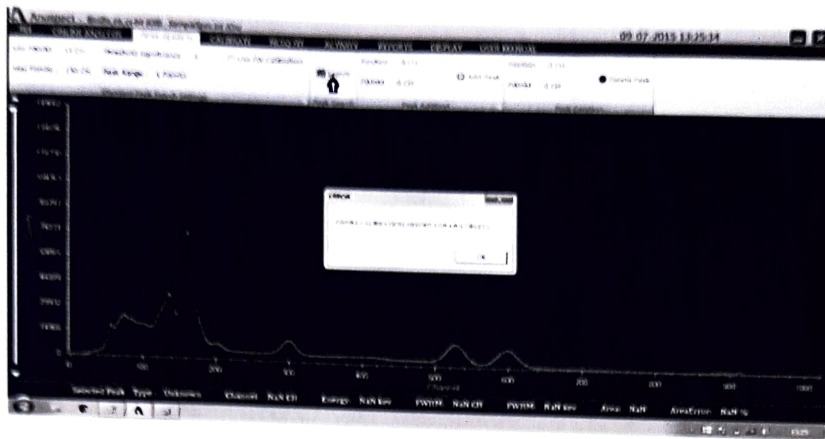

7. Go to Calibrate menu & click on energy after that right click on the spectrum, click input text box



8. Enter the energy in it, and drag it to the corresponding peak.

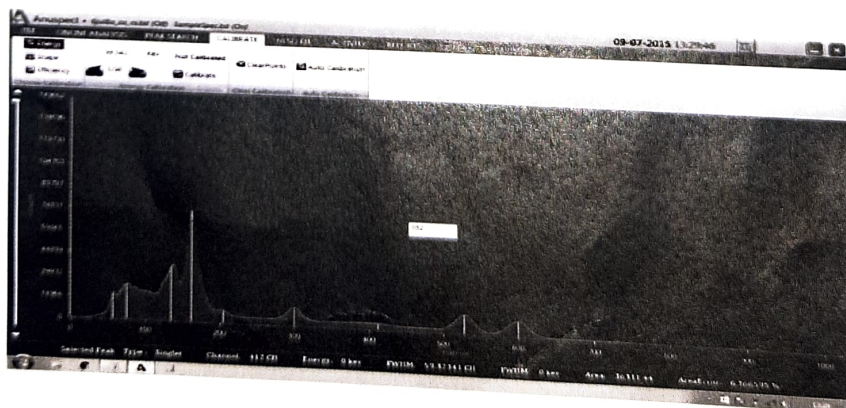

9. Repeat it for two more peaks

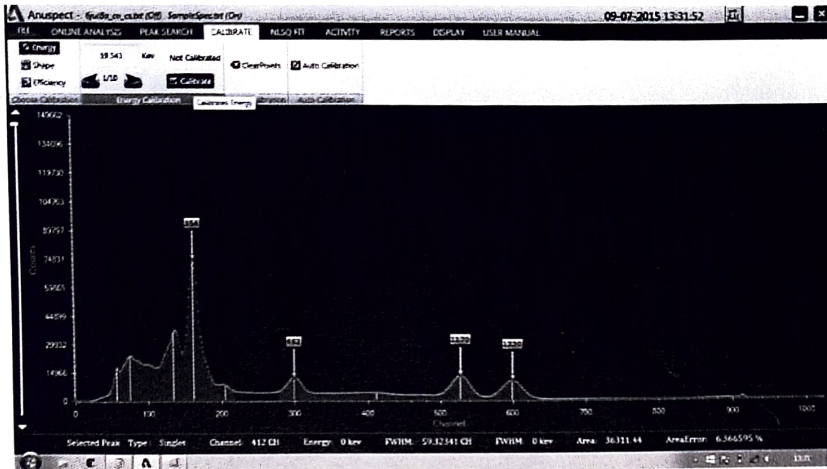

10. Click on Calibrate

11. We can see the polynomial equation & we can use this equation to find out the energy of unknown sample



12. To see the polynomial chart, right click on the spectrum, select show polynomial chart.

EXPERIMENT-4

ENERGY CALIBRATION OF GAMMA RAY SPECTROMETER(LINEARITY STUDY)

(MANUAL CALCULATION METHOD)

- 3 sources

Purpose:

To study the behaviour of the gamma Ray Spectrometer with different energies of Gamma Sources.

Procedure:

1. Make the system interconnections & default settings so as to get the Cs-137 peak approximately at channel 300.
2. Place different Energy sources on the detector 2cm away. (minimum 3 energies are required for Energy Calibration)
3. Acquire the spectrum to get a fine spectrum after giving the default settings and file name ~ 1500s
4. Click file menu, spectrum and load the spectrum to be calibrated energy shape.
5. Go to Peak Search menu and search the peak

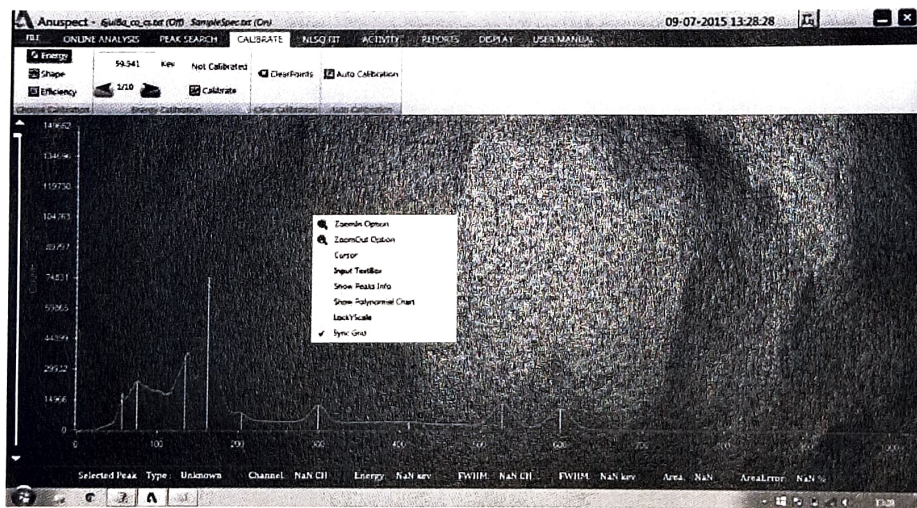

6. Right click on spectrum and select Show Peak Report/ROI, cursor.
7. Click on known energy peak, then corresponding peak will be selected in the peak table.

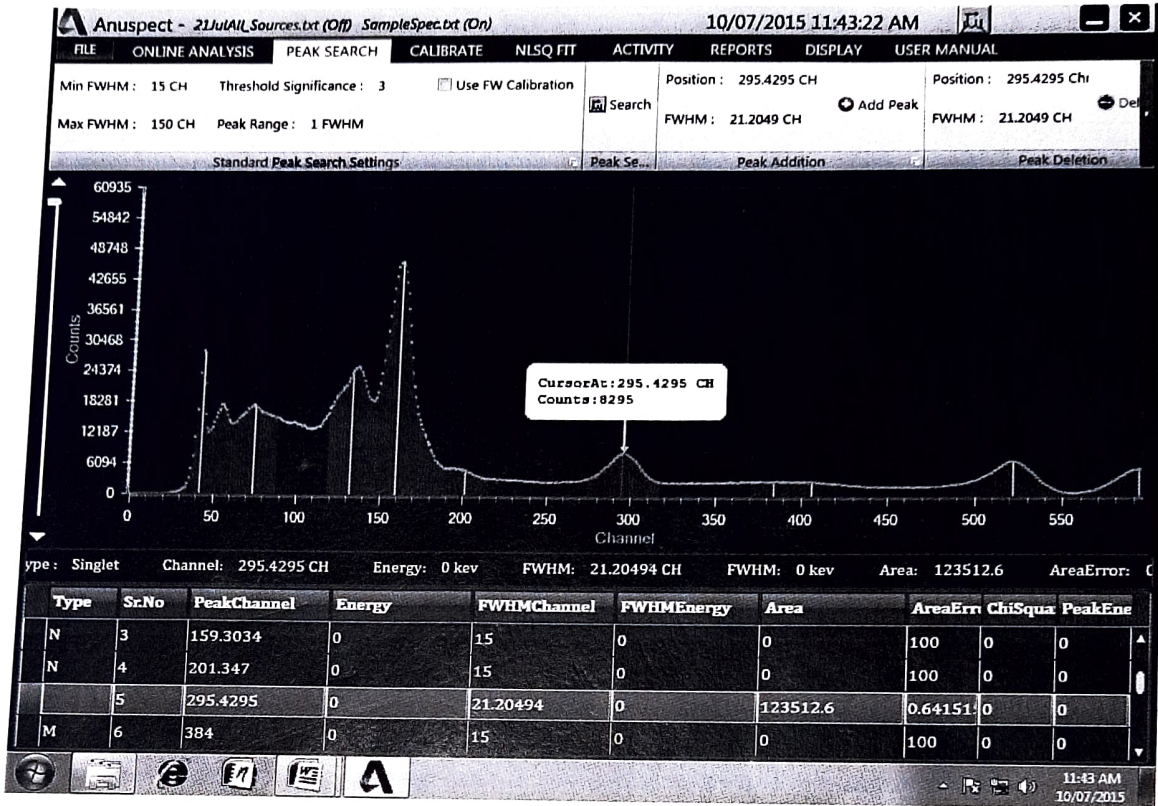

8. Note down the peak channel for that energy
9. And repeat for 2 more peaks and tabulate the data as followed

| Source | Energy in KeV | Peak Channel |
|--------|---------------|--------------|
| Ba-133 | 356 | 159.30 |
| Cs-137 | 662 | 295.42 |
| Co-60 | 1172 | 521.55 |
| Co-60 | 1335 | 591.82 |

10. A plot is drawn between energy and channel as shown in figure

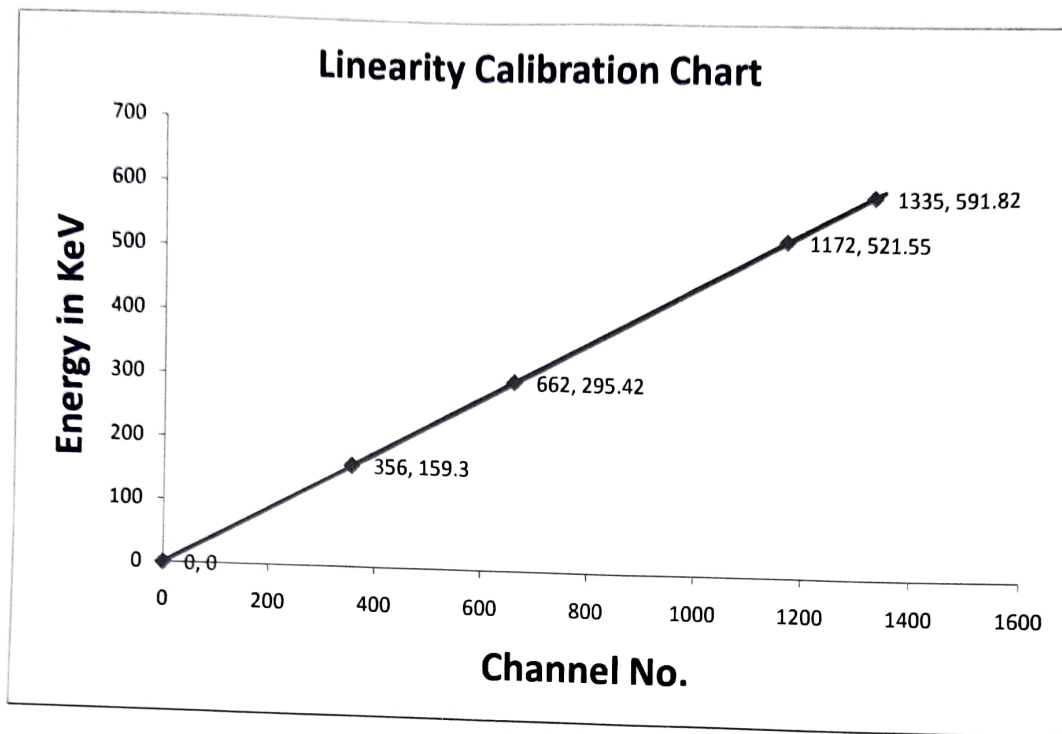

Hence, We conclude that the Peak Channel (Pulse Height) of the Gamma Rays is proportional to the energy of that Gamma Energy.

2

EXPERIMENT: 5

UNKNOWN ENERGY OF A RADIOACTIVE ISOTOPE (Na-22)

Purpose:

Unknown masked(Covered) disc source may be given to student to find out its Energy, along with a set of atleast three known Energies

Procedure:

1. This experiment should be followed by the previous experiment.
2. Now acquire the spectrum for the unknown sample for same experimental set up.
3. Load that spectrum and click on the peak channel (where the height of the photo-peak is maximum) and Note down the peak channel no.
4. Now extrapolate this channel no. On to the Energy Linearity Graph to calculate the energy of the unknown peak.
5. The Energy thus obtained should be matched for a known radio active standard source

EXPERIMENT – 12

MASS ABSORPTION COEFFICIENT

PURPOSE : The purpose of the experiment is to measure experimentally the mass absorption coefficient in lead for 662-keV gamma rays.

THEORY : It is well known that gammas interact with matter primarily by photoelectric, Compton, or pair-production interactions. The total-mass absorption coefficient can be measured easily with a gamma-ray spectrometer. In this experiment we will measure the number of gammas that are removed from the photo-peak by photo-electric or Compton interactions that occur in a lead absorber placed between the source and the detector.

From Lambert's law the decrease of intensity of radiation as it passes through an absorber is given by

$$I = I_0 e^{-\mu x}, \quad \text{----- (7)}$$

Where

I = intensity after the absorber,

I_0 = intensity before the absorber,

μ = total – mass absorption coefficient in cm^2 / g ,

X = density thickness in g / cm^2 .

The density thickness is the product of the density in g/cm^3 times the thickness in cm. The half –value layer (HVL) is defined as the density thickness of the absorbing material that will reduce the original intensity by one-half.

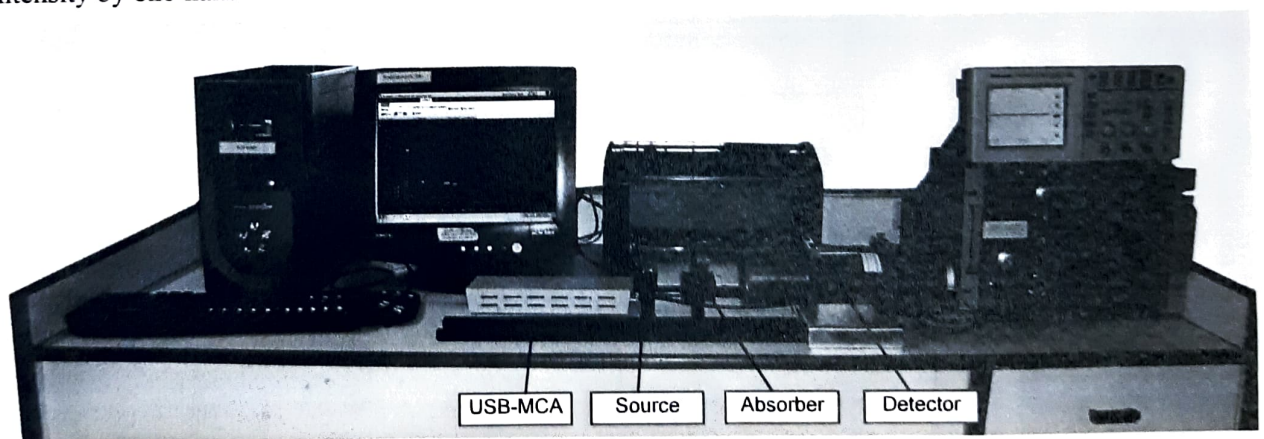

Fig. 22. Experimental setup

PROCEDURE:

1. Make system interconnections and default settings.
2. Set HV to 750volts.
3. Adjust the amplifier gain such that the photopeak of 662 KeV gammas will appear at approximately channel 300.
4. Set a live time of 250 Sec.
5. Insert the first piece of lead absorber (1.5 mm thick) between source and detector. Acquire the spectrum.
6. Repeat with additional pieces of lead absorber in increments of 1.5 mm until the gross area under the 662 keV photopeak falls upto 2000. Acquire spectrum for each thickness of lead absorber.
7. Obtain the background spectrum for the set live time of 250 Sec.
8. Take ROI reports pertaining to 662 keV peak of Cs-137, for the respective absorber thicknesses.
9. From the ROI reports, obtain the gross counts pertaining to 662 keV peak, against each absorber thickness.
10. Obtain the gross background counts from the ROI report pertaining to background.
11. Calculate the net counts for each absorber thickness. (net counts = gross counts – background counts).
12. Tabulate the data as shown in the following Table -7.

DATA :

Table-7 (FOR LEAD)

Background counts for 250 sec = 3080

| Data for Mass Absorption Coefficient of Lead | |
|---|-------------------|
| Thickness (mm) | Net counts |
| 0 | 260193 |
| 1.5 | 216338 |
| 3.0 | 183417 |
| 4.5 | 153091 |
| 6.0 | 130285 |
| 7.5 | 110772 |

| | |
|------|-------|
| 9.0 | 92732 |
| 10.5 | 77957 |
| 12.0 | 65243 |
| 13.5 | 54355 |
| 15.0 | 45207 |
| 16.5 | 37627 |
| 18.0 | 31805 |
| 19.5 | 26515 |
| 21.0 | 22077 |
| 22.5 | 18218 |

EXERCISE A : (FOR LEAD)

- Plot the Net Counts versus Absorber thickness in 'mm' as shown in the Fig. 22 and determine the Half Value Thickness or Half Value Layer (HVL) in terms of thickness (mm) from the Curve.
- The Half Value Layer (HVL) is also expressed in terms of Density thickness (gm/cm^2). Density thickness is the product of density in gm/cm^3 times the thickness in **cm**.
- Determine the HVL in gm/cm^2 and calculate the Mass Absorber Coefficient **m** from Eq. 10.
How does your value compare with the accepted value of $0.105 \text{ cm}^2/\text{gm}$?

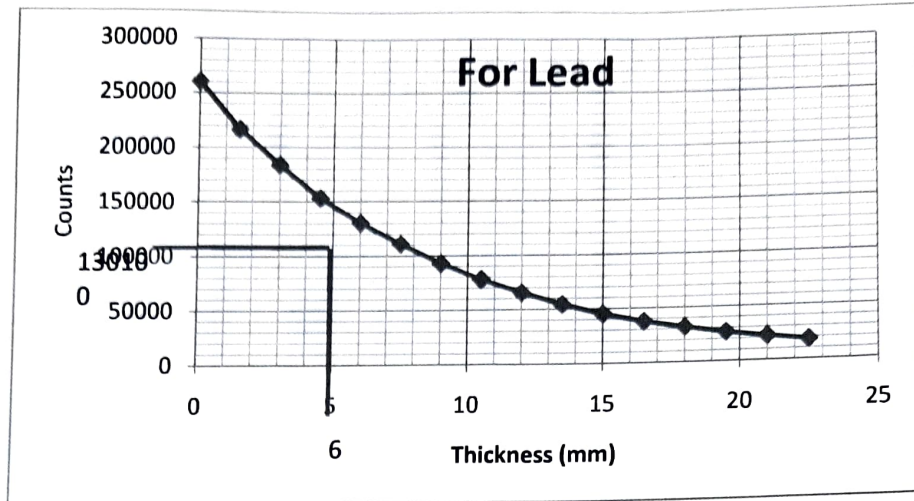

Fig. 22 Graph showing variation of counts with Lead absorber thickness

Computation & Result :

The observed value of HVL from the graph is 6mm or 0.6 cm.

Density Thickness = 0.6 x 11.34 = 6.804 gm/cm². (Density of lead = 11.34 gm/cm³).

Hence mass absorption coefficient

$$m = 0.693 / \text{HVL}$$

$$= 0.693 / 6.804$$

$$= 0.102 \text{ cm}^2/\text{gm}$$

This value 0.102 cm²/gm is very well in agreement with the accepted value of **0.105 cm²/gm**.

EXERCISE B: (FOR STEEL)

Procedure :

The experiment is repeated with steel absorbers in the same manner as was done with lead absorbers, except that the Cs-137 source is kept at a distance of 8 cm from the face of the detector.

In this experiment, the steel absorbers are incremented in the steps of 4 mm till a maximum thickness of 60 mm is reached.

Thickness Vs net counts are tabulated the following Table-8

DATA :

Table-8 (FOR STEEL)

Background counts for 250 sec = 3080

| Data for Mass Absorption Coefficient of stainless steel | |
|--|-------------------|
| Thickness (mm) | Net counts |
| 0 | 107312 |
| 4 | 88212 |
| 8 | 74429 |
| 12 | 60825 |
| 16 | 49682 |
| 20 | 40378 |
| 24 | 32545 |
| 28 | 26586 |
| 32 | 21800 |
| 36 | 17893 |
| 40 | 14308 |
| 44 | 11658 |
| 48 | 9531 |
| 52 | 7372 |
| 56 | 6086 |
| 60 | 5232 |

- Plot the Net Counts versus Absorber thickness in 'mm' as shown in the Fig. 23 and determine the Half Value Thickness or Half Value Layer (HVL) in terms of thickness (mm) from the Curve.
- The Half Value Layer (HVL) is also expressed in terms of Density thickness (gm/cm^2). Density thickness is the product of density in gm/cm^3 times the thickness in **cm**.
- Determine the HVL in gm/cm^2 and calculate the Mass Absorber Coefficient **m** from Eq. 10.

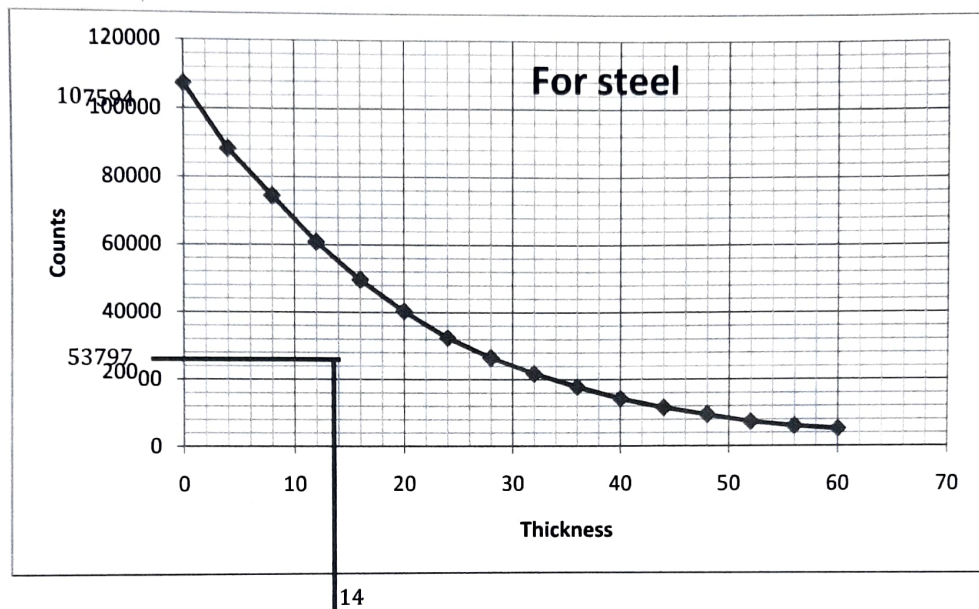

Fig.23 Graph showing the variation of counts with Steel absorber thickness

Computation & Result :

The observed value of HVL from the graph is 14 mm or 1.4 cm.

Density Thickness = $1.4 \times 7.75 = 10.85 \text{ gm/cm}^2$. (* Density of lead = 7.75 gm/cm^3).

Hence mass absorption coefficient

$$\begin{aligned}
 m &= 0.693 / \text{HVL} \\
 &= 0.693 / 10.85 \\
 &= 0.064 \text{ cm}^2/\text{gm}
 \end{aligned}$$

* **Note** : As the density of steel can vary between 7.5 and 8.0 the average value of 7.75 is considered for calculations.